

**60G millimeter-wave radar**  
**R60ABD2-H Breath & Sleep Radar**  
**Side Mounting**  
**Data Book V2.0**

## Contents

1. Product introduction .....	2
1.1 Product introduction .....	2
1.2 Theory of operation .....	2
1.3 Function description .....	2
1.4 Parameter settings .....	3
1.5 Applications .....	3
2. Product encapsulation diagram .....	3
3. Pin parameters explanation .....	4
3.1 Pin explanation .....	4
3.2 Serial port output parameters .....	5
3.3 Output protocol .....	6
3.4 Naming conventions of models .....	6
4. Product features .....	6
5. Electrical characteristics and parameters .....	6
5.1 Detection angle and distance .....	6
5.2 Electrical characteristics .....	7
5.3 RF performance .....	7
5.4 Response time .....	7
5.5 Application wiring diagram .....	8
6. Main functions and performance .....	8
6.1 Radar module coverage .....	8
7. Installation method and working modes .....	8
7.1 Installation method .....	9
8. Related documents .....	9
9. Notes .....	9
9.1 Start-up time .....	9
9.2 Effective distance of detection .....	9
9.3 Radar detection performance .....	10
9.4 Power source .....	10
10. FAQs .....	10
11. Disclaimer .....	10
12. Copyright notice .....	11
13. Contact .....	11
14. Revision History .....	12

**Notes:**

Click on the link or scan the QR code to make sure you're using the latest document:

[http://en.micradar.cn/go\\_file.php?id=201](http://en.micradar.cn/go_file.php?id=201)

**1. Product introduction****1.1 Product introduction**

The R60ABD2-H radar module employs 60 G millimeter-wave radar technology to realize breath & heartbeat sensing and sleep assessment. Based on the 1T3R FMCW (frequency modulated continuous wave) signal processing mechanism, this module performs wireless sensing on the status of people in the specific sleep areas.

Radar frequency band	60G millimeter-wave radar
Number of antennas	1T3R
Detection system	FMCW
Active detection	Heartbeat & breath, body movement parameter
	Sleep status, sleep quality



Fig. 1 Front and back sides of the radar

**1.2 Theory of operation**

The radar antenna transmits electromagnetic wave signals, and synchronically receives reflected echo signals. Then, the radar analyzes the phase difference and energy change between waveform parameters of the echo signals from varying antennas, and gives feedback on subtle motion power change, distance, orientation, speed, and other information of the target, to detect the target's sleep state and chest expansion with breath.

**1.3 Function description**

- Motion detection amplitude: Motion information output, such as walking and minor arm swings, can be detected within the range of the radar, upon which the human presence state will be triggered.

Subtle motion detection function: When someone stays still in the detection range of the

radar, his/her subtle motion arising from breath, such as chest expansion, can be detected, and the state of human presence will remain.

- Sleep detection: Within the detection range of the radar, the sleep state of a person is determined in real time and sleep data is recorded, including information on the wakefulness, light sleep, deep sleep, and their duration. After the person has waken and left, a sleep score and sleep quality report are output.
- Breath & heartbeat frequency acquisition: When someone stays still in the detection range of the radar, his/her subtle motion arising from breath and heartbeat, such as chest expansion, can be detected and summarized for outputting the respiration and heartbeat rates per minute.

#### **1.4 Parameter settings**

- Human presence function switch: control whether human presence function data is actively reported
- Breath detection function switch: control whether breathing detection function data is actively reported
- Heartbeat detection function switch: control whether heartbeat detection function data is actively reported
- Sleep monitoring function switch: control whether sleep detection function data is actively reported
- Non-presence timer function switch: control whether the prolonged non-presence alarm function is enabled
- Non-presence timing settings: adjust the duration for judging the prolonged non-presence alarm
- Sleep cut-off time setting: Adjust the non-presence duration pf person out of bed for sleep cutoff.

#### **1.5 Applications**

- House intelligence
- Smart appliances (ACs, loudspeakers, etc.)
- Regional human detection
- Sleep care

## **2. Product encapsulation diagram**

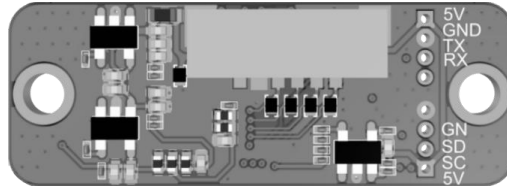

Fig. 2 Schematic diagram for radar module frame

- Volume: 33mm×12mm
- Interface: The dimensions of the 6-pin vertical power strip connection interface are as follows:

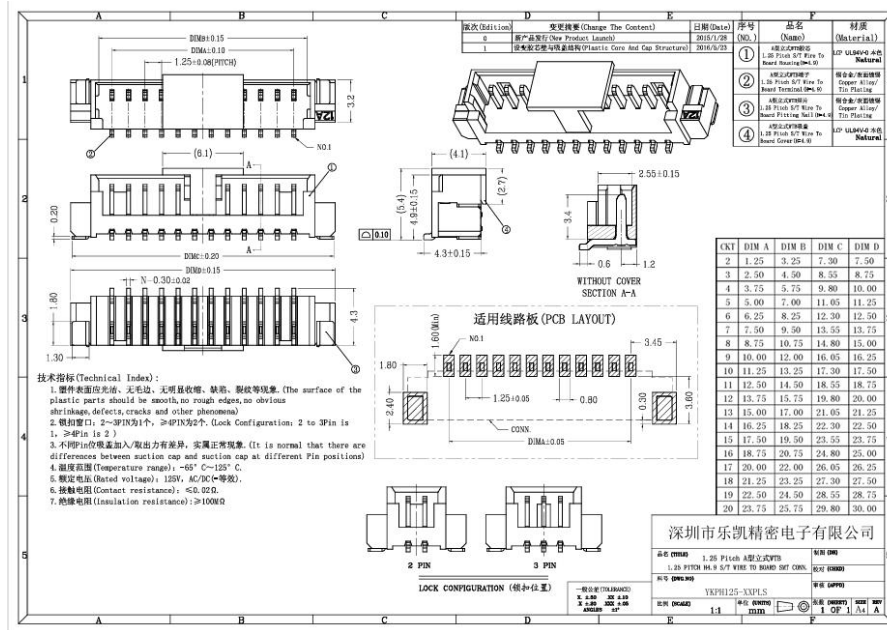

Fig.3 Product specification diagram

### 3. Pin parameters explanation

#### 3.1 Pin explanation

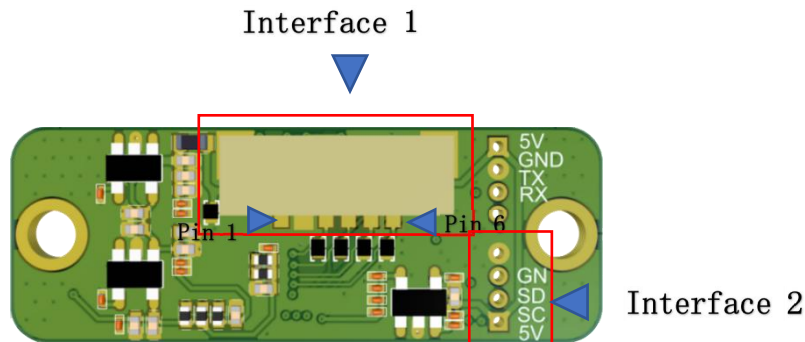

Fig. 4 Radar Pins

Interface	Pin	Description	Typical value	Notes
Interface 1	1	5V	5.0V	Power input positive
	2	GND		Ground
	3	RX	3.3v	Serial port reception, 3.3V TTL level
	4	TX	3.3v	Serial port transmission, 3.3V TTL level
	5	GP2	3.3V/0V	Spare extension pin
	6	GP1	3.3V/0V	Spare extension pin
Interface 2	1	3V3	3.3V	Output power
	2	GND		Ground
	3	SWC		Burning pin 1
	4	SWD		Burning pin 2
	5	GP3		Spare extension pin
	6	GP4		Spare extension pin
	7	GP5		Spare extension pin
	8	GP6		Spare extension pin

Interface 1: for user usage

Interface 2: debugging interface for the radar's internal firmware burning

Note: The output signals from this interface are all 3.3 V in level.

### 3.2 Serial port output parameters

- Presence/Non-presence
- Active/Still
- Body movement parameter
- In/Out of bed
- Sleep status: Awake/Light Sleep/Deep Sleep
- Sleep score/sleep rating
- Sleep quality analysis
- Prolonged non-presence abnormality judgment
- Respiratory rate
- Respiratory waveform

- Heartbeat frequency
- Heartbeat waveform
- Product Info

### 3.3 Output protocol

- SIP-S v1.0 Serial port protocol
- Tuya protocol

### 3.4 Naming conventions of models

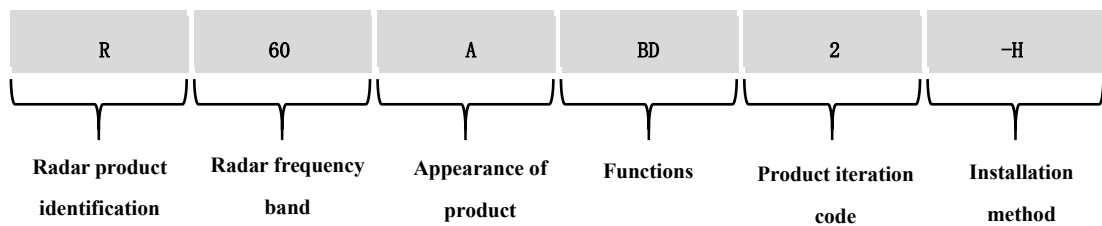

Fig. 5 Naming conventions of models

## 4. Product features

The R60ABD2-H radar module adopts 1 transmitting and 3 receiving antennas. The wide-beam radar module is mainly applicable to top mounting. It controls the angle and coverage via algorithms, and accurately scans the full-body motion tomography to realize sleep detection of people who are static and moving as well as acquisition of breath & heartbeat data under different postures.

This radar module features the following:

- The product supports secondary development, making it applicable to a variety of scenarios;
- The module adopts universal UART communication interface and universal protocol provided;
- The module is of small output power and hence harmless to health;
- The module is immune to temperature, lighting, dust and other factors while bearing high sensitivity, making it applicable in a variety of scenarios;

## 5. Electrical characteristics and parameters

### 5.1 Detection angle and distance

Parameter details	Minimum	Typical value	Maximum	Unit	Installation method
-------------------	---------	---------------	---------	------	---------------------

R60ABD2-H					
Presence detection distance	1.2	1.5	1.8	m	Horizontal mounting
In-bed detection distance (chest)	0.9	1	1.1	m	
Detection distance of sleep (chest)	0.4	-	2	m	
Non-presence detection distance	2.5	-	3	m	
Detection distance of breath and heartbeat (chest)	0.4	-	1.5	m	
Measurement range of breath	10	-	35	times/min	
Measurement range of heartbeat	60	-	120	times/min	
Angle of radar detection (horizontal)	-	60	-	Degree(s)	
Angle of radar detection (inclined)	-	60	-	Degree(s)	

## 5.2 Electrical characteristics

Working Parameters	Minimum	Typical value	Maximum	Unit
Working voltage (VCC)	4.5	5	5.5	V
Average current (ICC)	-	-	100	mA
Peak current	-	-	300	mA
Working temperature (TOP)	-20	-	+55	°C
Storage temperature (TST)	-40	-	+85	°C

## 5.3 RF performance

Transmission parameter	Minimum	Typical value	Maximum	Unit
Working frequency (fTX)	61	-	62.5	GHz
Transmission power (Pout)		8	10	dBm
Antenna gain (GANT)		8		dBi

## 5.4 Response time

Response time	Minimum	Typical value	Maximum	Unit
resence	3	-	5	s



In Bed	3	-	40	s
Out of Bed	30	-	50	s
Non-presence	48	-	60	s

## 5.5 Application wiring diagram

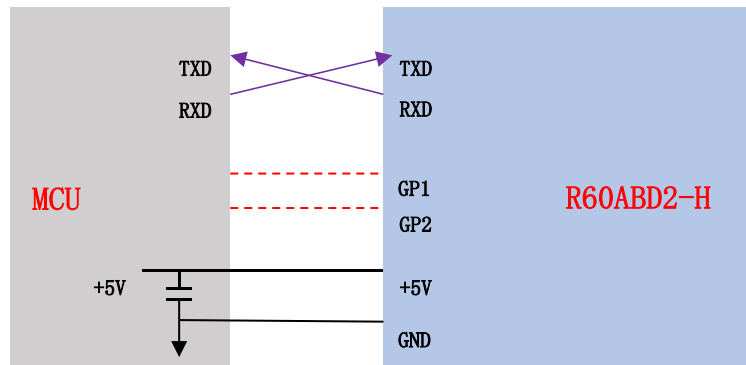

Fig. 6 Schematic diagram for connection between radar module and peripherals

## 6. Main functions and performance

### 6.1 Radar module coverage

The beam coverage of the radar module is shown in Fig. 7. The coverage of the radar is a three-dimensional sector  $60^\circ$  horizontally and  $60^\circ$  vertically.

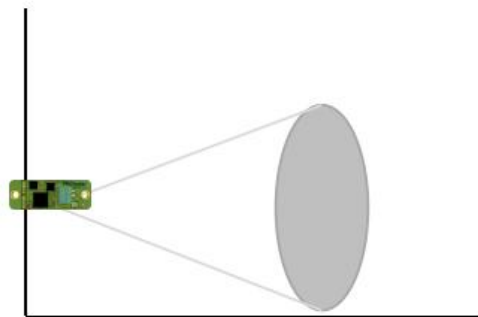

Fig. 7 Diagram for coverage of radar beams

Affected by the characteristics of radar beams, the operating distance along the normal line to the antenna face is greater, while the one displacing from it is smaller.

Attention should be paid that when the radar is of horizontal mounting, the range of the radar will be reduced as a result of radar beam coverage and effective radiation space.

## 7. Installation method and working modes

## 7.1 Installation method

For sleep detection, the radar needs to be side-mounted horizontally (as shown in Fig. 8).

- (1) Place the module horizontally on the bedside table, and make sure that its front is not blocked.
- (2) The module should be positioned at least 15 cm above the bed surface (no more than 30 cm), to ensure the module (detection antenna surface) facing the chest area after the person lies down on the bed
- (3) If the module is 30 cm above the bed surface, please adjust the detection antenna of the module to face downward (with the bracket) to ensure that the radar can directly face the chest area after the person lies down on the bed
- (4) Keep a distance of within 1.5 meters between the radar and the person

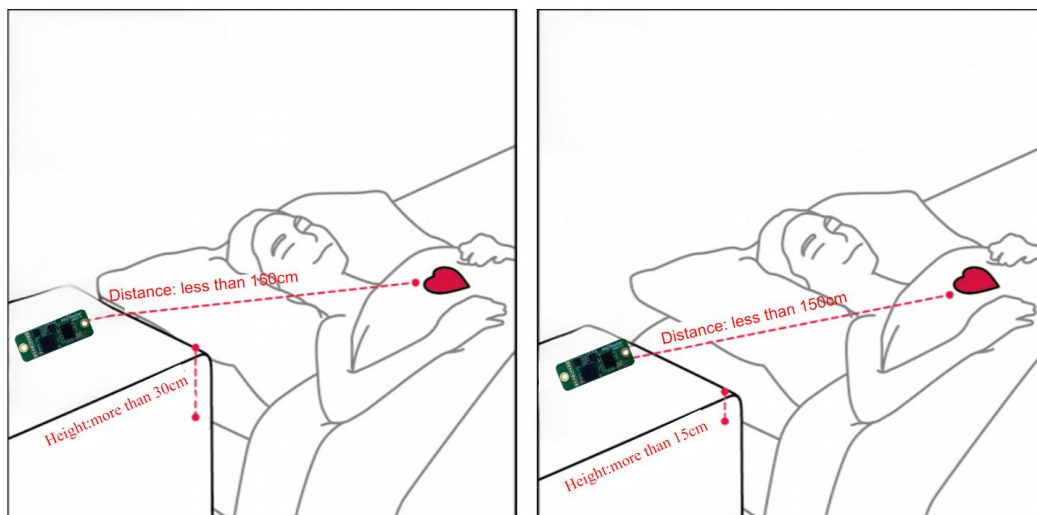

Fig. 8 Schematic Diagram of Horizontal Side-Mounting of Bedside Tables

## 8. Related documents

- User Manual: [http://en.micradar.cn/go\\_file.php?id=202](http://en.micradar.cn/go_file.php?id=202)

## 9. Notes

### 9.1 Start-up time

The module needs to fully reset its internal circuits and performs a full assessment on ambient noise when it is powered on and starts to work, so as to ensure the module can work properly. As a result, the module requires a stabilizing time  $\geq 30$  s upon powering on to ensure the effectiveness of parameters output subsequently.

### 9.2 Effective distance of detection

The distance of detection of the radar module depends mainly on target RCS, covering

material and thickness, as well as environmental factors, and might vary with the environment and the target. Therefore, it's normal for the effective distance of detection to fluctuate in a certain range.

### 9.3 Radar detection performance

For static human presence, the detection is more effective when human chest is facing the radar. However, when a person turns sideways or backward during detection, there is a risk that the radar may not detect chest movement, leading to the possibility of not detecting the person.

Due to the fact that the biological features of human bodies are characteristic signals of super low frequency and weak reflection, long-period accumulation is required for radar processing. However, a number of factors might affect the parameters of the radar during the course. On this account, it's normal that detection fails sporadically.

### 9.4 Power source

- 1) The radar module has requirements higher than regular low-frequency circuits on power source quality. When supplying power to the module, the power source is required to be free from any threshold glitches or ripples, and can effectively shield power supply noise from accessories.
- 2) The radar module requires proper grounding. Ground noise from other circuits might compromise the performance or even cause an anomaly in the module. A reduced distance of detection or increased false alarm rate is one of the commonest.
- 3) To ensure the VCO circuit inside the module works properly, power supply to this module should be +4.9V - +5.5V, with ripple voltage  $\leq 100$  mV. External power supply must be able to provide sufficient current output and transient response capacity.

## 10. FAQs

- Interference factors: The radar is a sensor for electromagnetic wave detection. Inanimate objects that are moving can lead to a false alarm. The flowing liquids, oscillating fans, and shaking curtains may cause false alarms. Therefore, the radar should be installed in such a way that its detection area is as free as possible from the above interference items.
- Housing factors: Many other factors affect radar performance, such as the material of the housing that the radar beam needs to penetrate, the surface treatment of the housing, and the distance between the radar antenna surface and the housing. Please follow our recommendations for housing and installation design.

## 11. Disclaimer

To our best knowledge, the description in the document is accurate when it was released. Considering the technical complexity of products and the differences in working

environments, it's impracticable to eliminate each and every inaccurate or imperfect description. On this account, this document is for reference by the user only. We reserve the right to make any changes to the product without a prior notice to the user. We make no commitments nor guarantees on the legal level. We encourage the customers to give valuable opinions on the update on the product and its supportive tools.

1) Although we strive to improve the quality and reliability of our products, there is a probability of false alarms in the testing of millimeter-wave products.

2) To avoid any harm, disaster, or social damage caused by the malfunction of our millimeter-wave products, customers are advised to implement safety designs such as fail-safe designs, redundancy designs, fire prevention designs and fault tolerance designs, to ensure the safety of their equipment.

3) Please contact our sales office in advance, if this product is used in the following equipment that requires particularly high reliability:

For example, aerospace equipment, submarine equipment, power generation control equipment (nuclear, thermal, hydro, etc.), life-support medical equipment, disaster/crime prevention equipment, movable object control equipment (cars, planes, trains, ships, etc.), and other safety equipment.

4) If you intend to use this product under conditions different from our recommendations, please provide a separate certificate of compliance with technical standards or construction designs for your system.

5) When operating this product, you must take anti-static measures, such as grounding the measurement system and grounding the human body. In addition, when this product is placed in a reflow oven, please handle it according to the MSL classifications.

6) Please note that applying stress to the external form of this product may affect local oscillation frequencies. When multiple modules are used in the same area, please consider preventing interference.

7) Do not use this product under conditions out of the specifications listed in this manual, as this may result in product degradation or damage.

8) We are not responsible for any harm, accident, or social damage caused by the use of this product under conditions out of relevant specifications.

## **12. Copyright notice**

All elements and parts mentioned herein constitute a reference to publications disclosed by the corresponding copyright holders, who shall reserve the rights to modify and publish the same. Please confirm the updates and corrigenda of such information via appropriate channels prior to any use of them. We hold no rights and obligations as for these publications.

## **13. Contact**

Yunfan Ruida Technology (Shenzhen) Co., Ltd.

Email: sales@micradar.cn.

Telephone: 0755-88602663

Address: 501, West Block, Tian'an Innovation Technology Plaza (Phase 2), Futian District, Shenzhen, Guangdong Province

## 14. Revision History

Revision	Release Data	Summary	Author
V1.0	2023/2/16	Draft	Mark
V1.1	2023/3/12	Adjusted the composition of the front portion of the document	Mark
V2.0	2024/10/23	First edition of new version	Mark